

Luminaire with pre-installed cable

1. Unpack the luminaire.

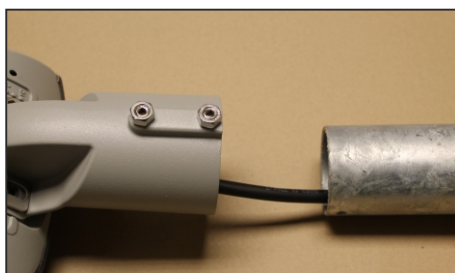

2. Prepare the luminaire for the installation.



3. Connect the 3 core cable to the power supply (Class I.).

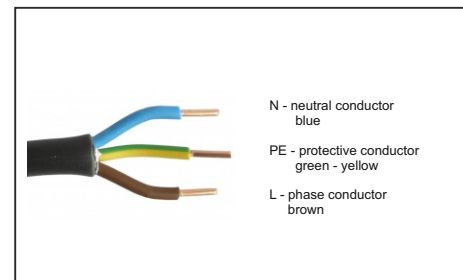

4. Connect the 5 core cable to the power supply (Class I.).

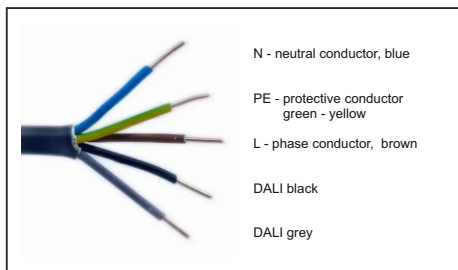

5. Connect the 2 core cable to the power supply (Class II.).

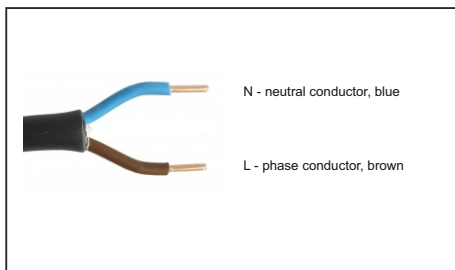

6. Connect the 3 pin connector Gesis to the power supply (Class I.).

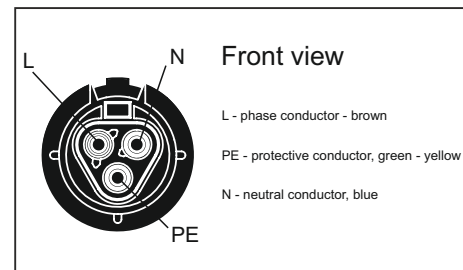

7. Connect the 5 pin connector Gesis to the power supply (Class I.).

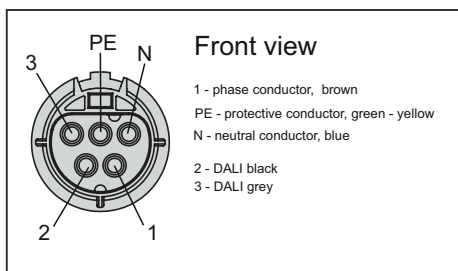

8. Connect the 2 pin connector Gesis to the power supply (Class II.).

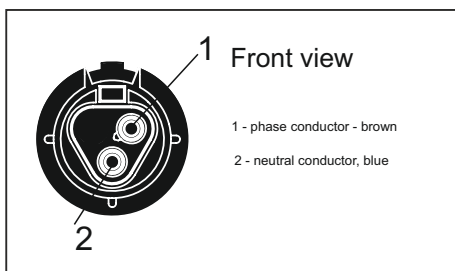

9. Fix the luminaire on the post or outrigger.

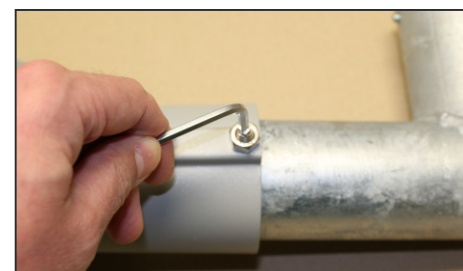

Luminaire without pre-installed cable

10. While installing the luminaire on outrigger, push the cable through a cable gland into the luminaire.



11. Strip the end of the cable (7 cm) and the ends of the wires (1 cm)



12. Connect wires to the disconnecter.
L - phase conductor, brown
PE - protective conductor, green - yellow
N - neutral conductor, blue



13. Tighten the cable gland.



14. Close the luminaire and secure with clips.



15. Orientation of the luminaire for the post installation.

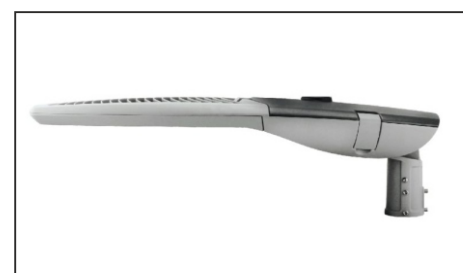

16. Orientation of the luminaire for the outrigger installation.

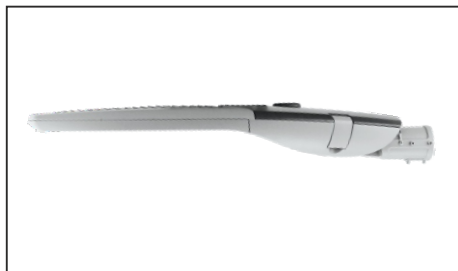

17. Tighten two screws with tightening torque of 10 Nm and secure with nuts

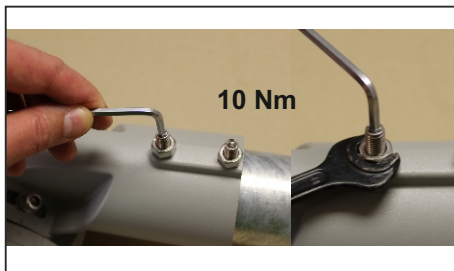

18. Loosen two imbus screws to set an angle of the luminaire. Tightening torque of 10 Nm.



$A_{w\downarrow} = 0,061 \text{ m}^2$

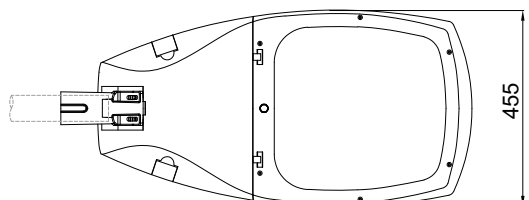

$A_{w\downarrow} = 0,34 \text{ m}^2$

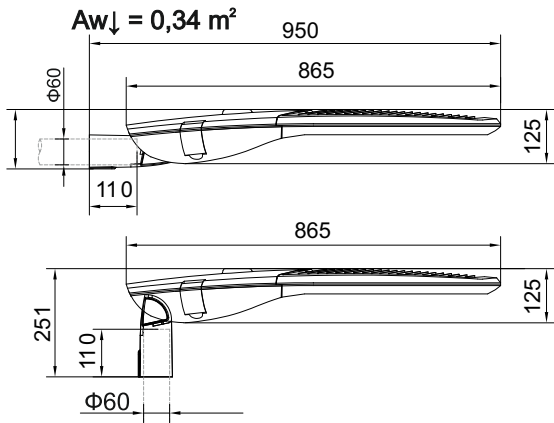

 = 15,2 kg

- Recommended installation height up to 15 meters.

- If the external flexible cable or cord of this luminaire is damaged, it shall be exclusively replaced by the manufacturer or his service agent or a similar qualified person in order to avoid a hazard.

- The light sources in this luminaire is only replaceable by the manufacturer or their technicians or a qualified person.

- **Caution, risk of electric shock** 

- Do not look directly or with optical aids into the light source RG1 $d > 0,5 \text{ m}$



- This luminaire operates at mains voltage 220-240V, 50-60 Hz.

- Any modification to this luminaire is forbidden.

- Replace any cracked protective shield.

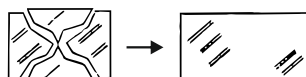

Cleaning:

clean the luminaire with the standard detergents. DO NOT use any abrasive detergents or solvents.

Installation and maintenance:

can provide only a person with an electrical qualification.

ELEKTRO-LUMEN, s. r. o.
Hranická 505
753 61 Hranice IV - Drahotuše
Česká republika

Telefon: +420 581 699 411
Fax: +420 581 699 419
E-mail: el-lumen@el-lumen.cz
Web: www.el-lumen.cz

